

ADLIS

**SMART BENCH
SMART CONTAINER
SMART HOME
SMART SECURITY**

WEIYIN

TECHNOLOGY

DATA SHEET: WYR1808

ECOLOGY
Decreasing energy consumption and the CO2 emission

Led light Spot Light





INDUCTIVE CHARGER
Our solar benches are equipped with wirelessly charger



USB CHARGER
Charge your phone via USB. 24 hours per day

WIFI INTERNET
Free internet access while charging

Characteristics

Model	WYR1808	Appearance	
Size	327CM*50CM*80CM		
N.W.	70KG		
G.W.	90KG		
Certificate	CE ISO		
Function	In sunlight condition, product will charge build-in Li-ion battery by solar panel, and charge cell phones by cables simultaneous. Without sunlight condition, product will charge cell phone by its built-in battery.		
Material	Stainless steel #201 + WPC WOOD		
Solar panel	NO		
Solar power	NO		
AC power	YES		
Controller	NO		
Battery type	NO		
Working temp.	-20C to 65C		
Battery capacity	NO		
USB charger	4PC - 5V/9V/12V (2.1A) Automatically applicable to all requirements.		
Wireless charger	1PC - Qi Standard		
LED light	LED Strip RGBW/Warm White		
Advertising display	NO		
WiFi router	4G/International router		
Bluetooth/speaker	5V/12V		
Cooling System	NO		
Sensors (Optional)	Light, Humidity, Temperature, Water, CO2, Noise, PM2.5, Counter, Alarm		
App Adlis Smart	App + Tablet 10": Optional		
Adlis Smart Platform	Smart Platform + Subscription / Contact Adlis Smart: sales@adlissmart.com		
Warranty	1 Year		
Battery notice	The controller works well above -40°C , while the working efficiency of battery is getting less and less under 0°C, when -10°C it already doesn't work. Yet after the temperate rises back to over 0°C, it will work again. Therefore, in very cold winter the chargers on bench don't work. In good sunshine, the battery is fully charged in about 7-8 hours.		

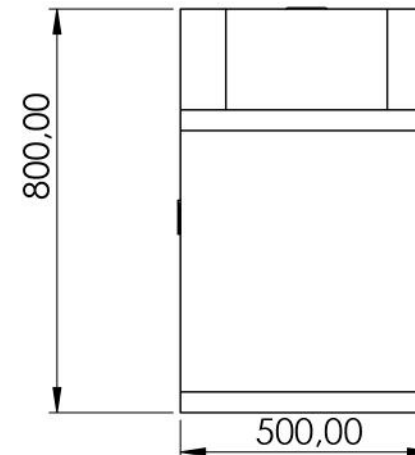
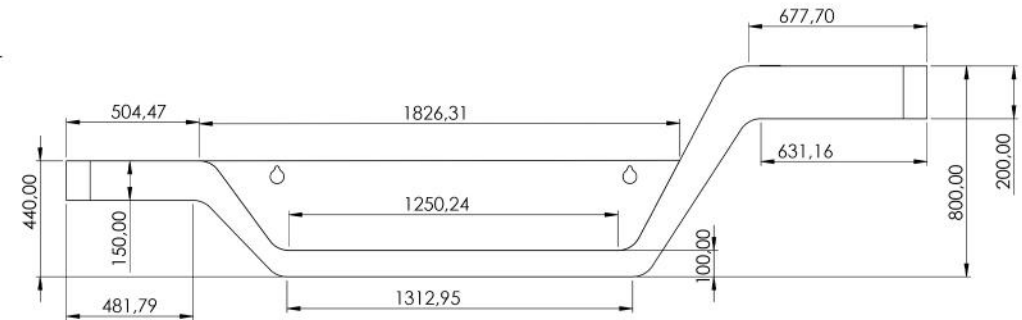
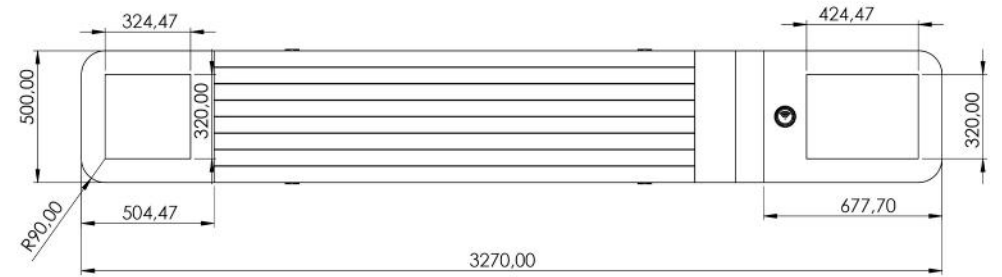
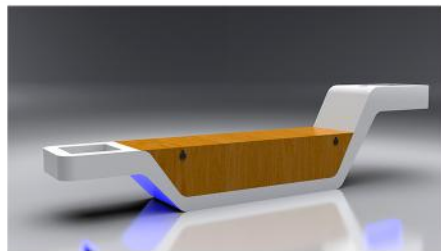
ADLIS 
WEIYIN



A. Description and function:

In sunlight condition, product will charge build-in Li-ion battery by solar panel, and charge cell phones by cables simultaneous. Without sunlight condition, product will charge cell phone by its built-in battery.

B. Intended use:

 This product is intended for outdoor use only. Please place it on a flat floor and away from any shade. If in the shade, the solar panel will not function effectively.

C. Package Content:

D. Safety instructions:



ATTENTION!

We recommend that a qualified person use it to assemble and disassemble the product to avoid any risk of product deterioration.

The product is self-service, that is, users do not need help to charge their device.

Read carefully and follow the safety instructions for care, maintenance, storage and transport.

We recommend using the original packaging for transportation to protect the product from dust and moisture.

- We are not responsible for damage to persons or property caused by improper installation or operation not described in this guide. Any alteration and / or modification of the product or its accessories immediately voids the warranty.

E. Connection and operation:

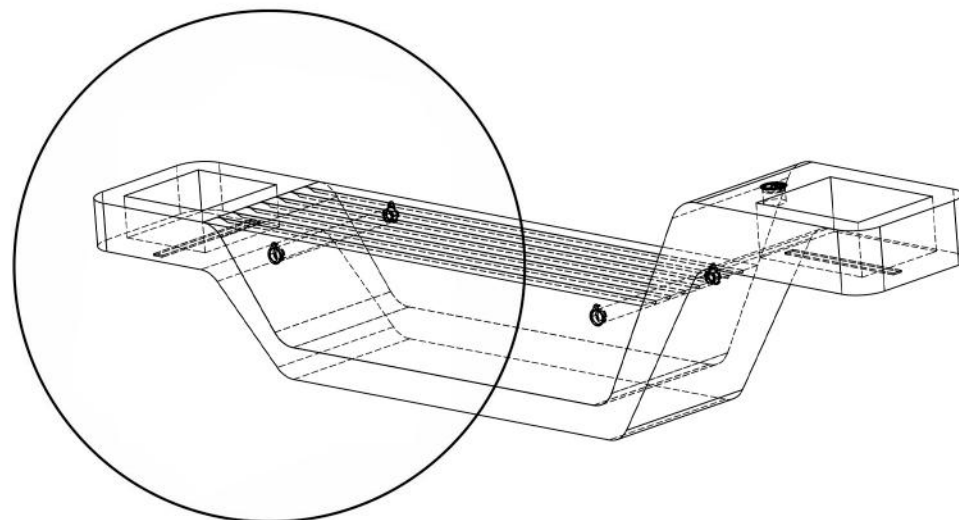

F. Care, maintenance, storage and transport:



WARNING!

We recommend that a qualified person use it to assemble and disassemble the product to avoid any risk of product deterioration.

- We grant a conditional warranty of 2 year for this device from the purchase data.
- The warranty also does not cover accidental damage or vandalism caused to the product.
- The warranty also does not cover the charging cables. We have no control over how users treat cables once the product is installed on your premises; replacement cables can be purchased at an additional cost.
- We are not responsible for damage to persons or property caused by improper installation or operation not described in this guide. Any alteration and / or modification of the product or its accessories immediately voids the warranty.

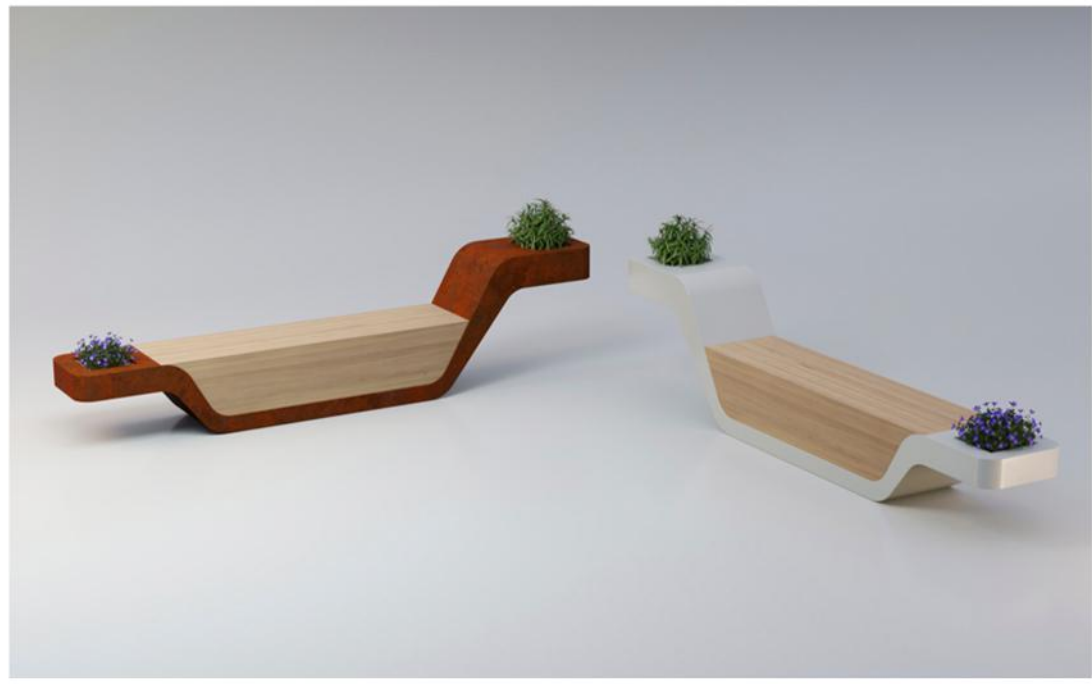
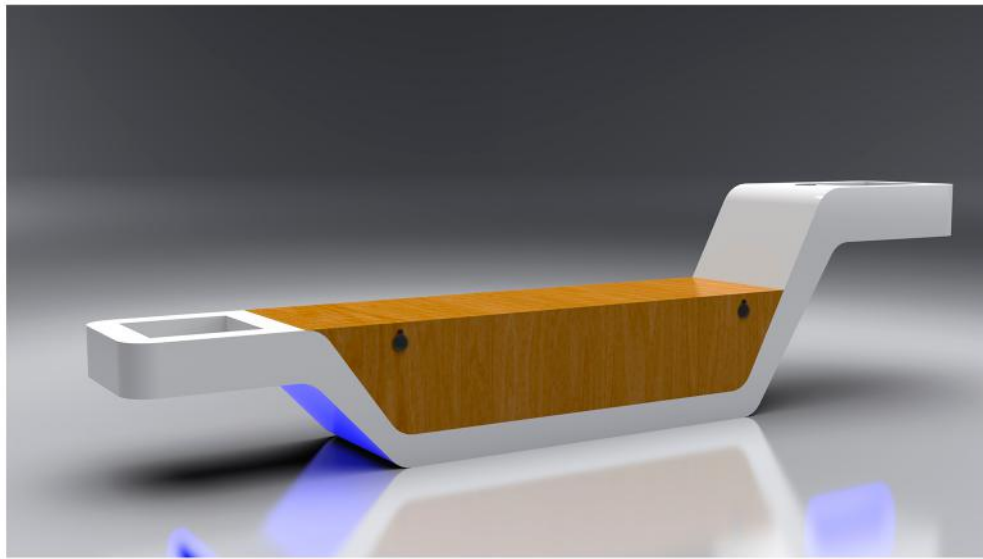
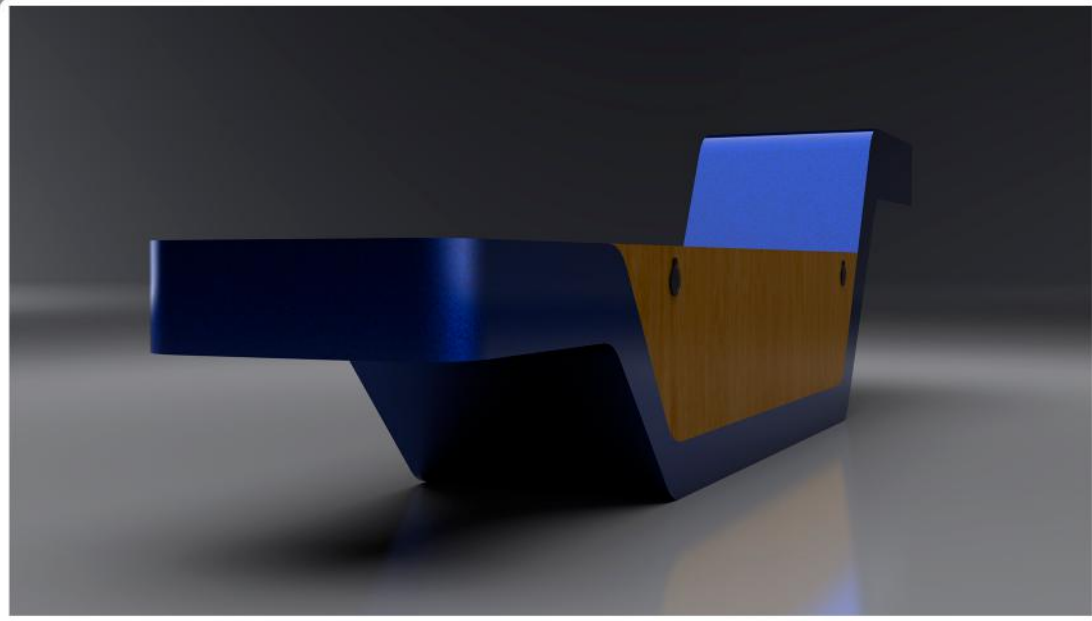
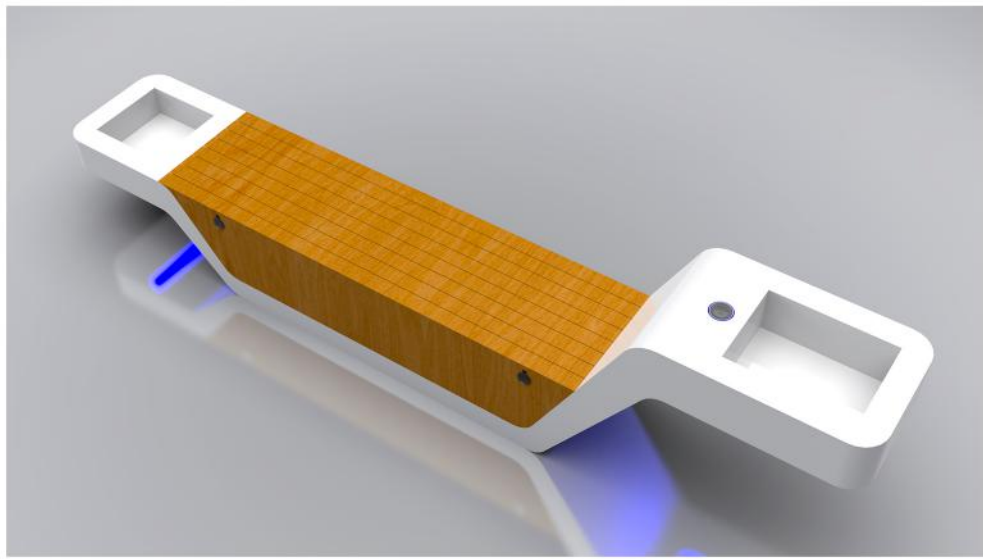

ADLIS 
WEIYIN

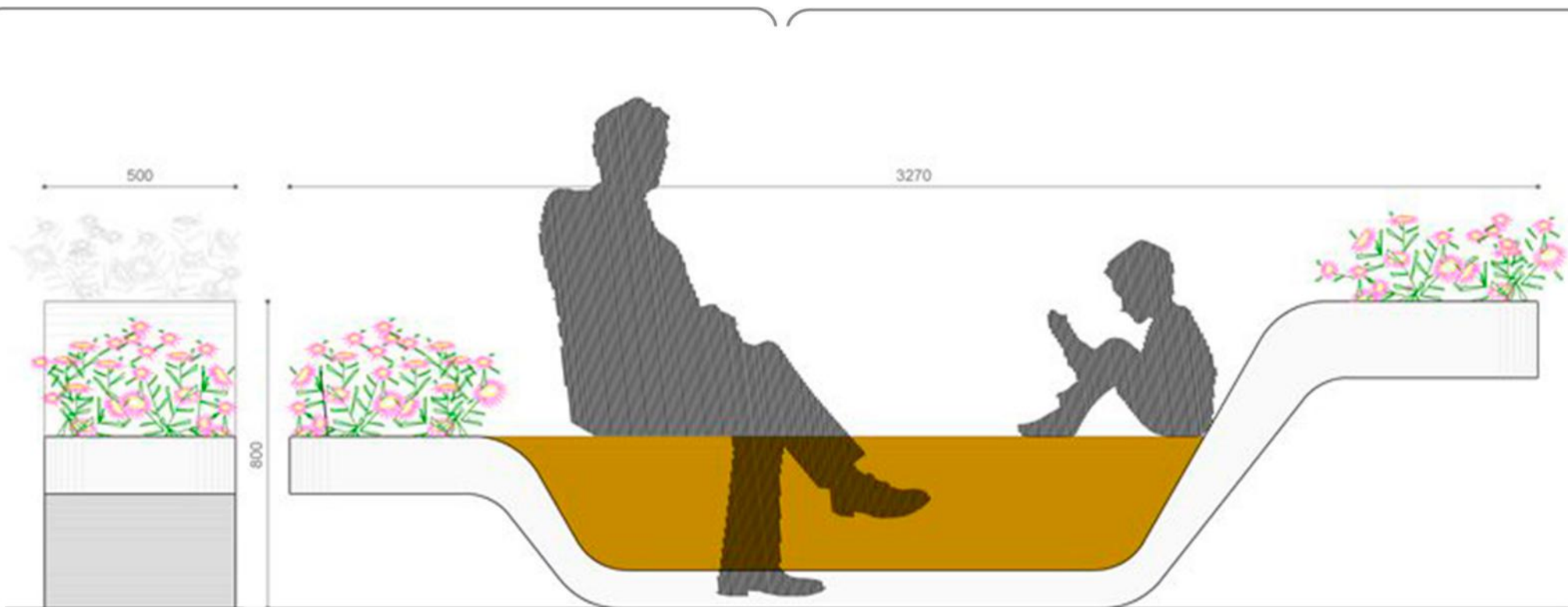



Brands and Numbers	Property Description	UNITS	UNITS/ CTN	CTNS	G.W.(kgs)	N.W.(kgs)	MEAS (CM)
ADLIS/WEIYIN CORPORATION	WYR1808	1	1	1	80	60	330*54*85
Total		1	1	1	80	60	0.837CBM



REMARKS: ALL PRODUCTS ARE PACKED IN POLYWOOD BOXES.

This packing detail is for 1pc sample, for bulk order the detailed packing details will be provided before shipment.